

DIN 332-DR M6
DIN 6885 Teil1

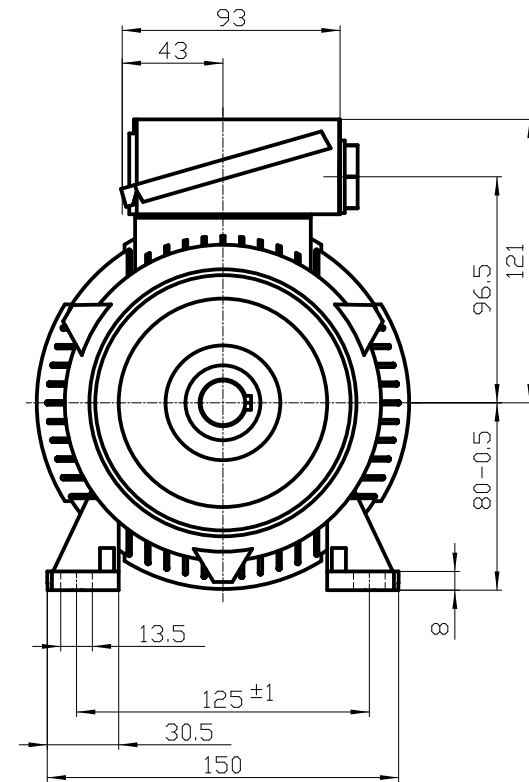
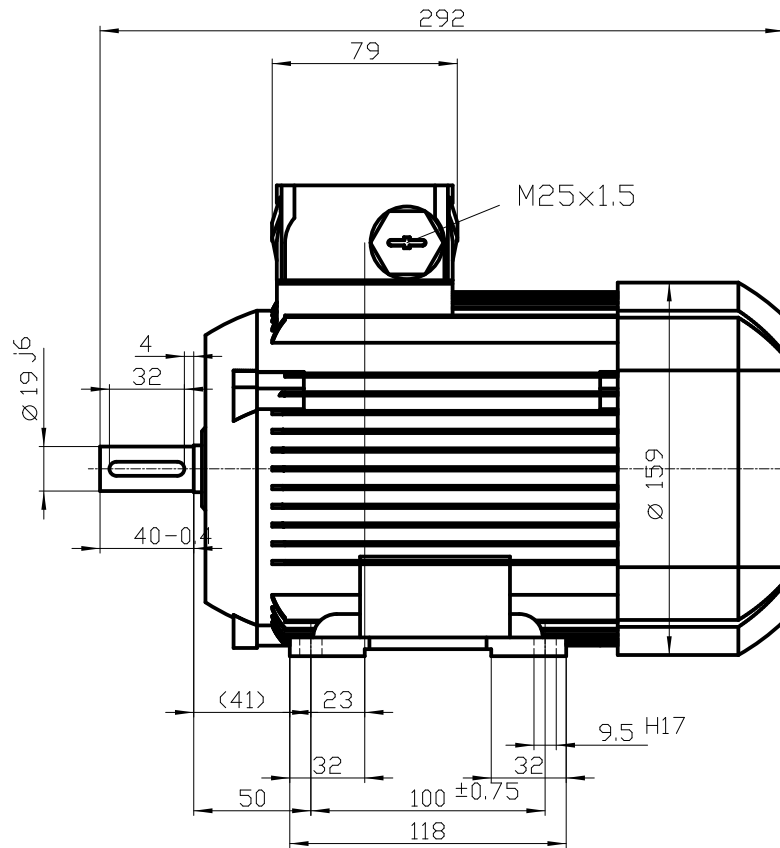

Unit	mm		
Date	22/07/2014	1TZ9001-0DA22-2AA4	
<small>Diese Umrisszeichnung ist Änderungen vorbehalten / This outline drawing is subject to change</small>			