

DIN 332-DR M8
DIN 6885 Teil1

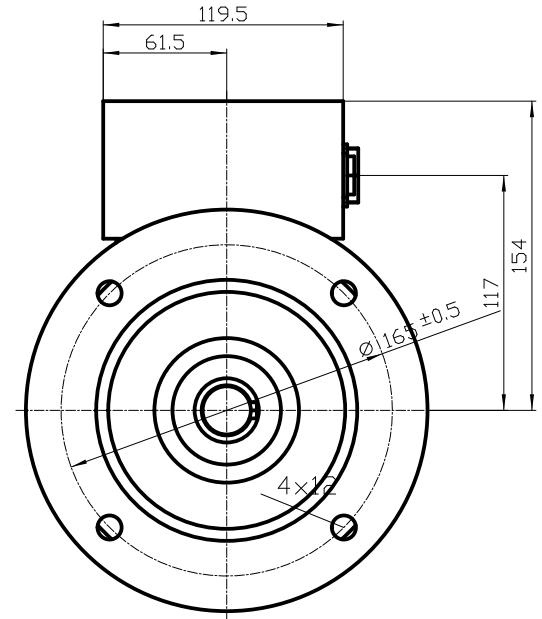
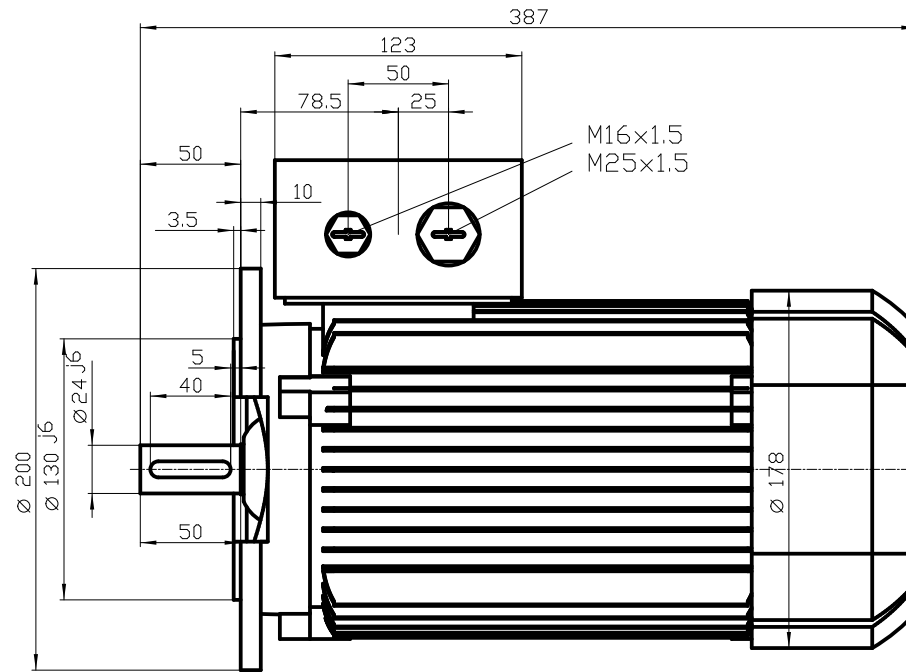

		-	
		-	
Unit	mm	1TZ9003-0EC42-2FA4	
Date	22/07/2014		
Diese Umrisszeichnung ist Änderungen vorbehalten / This outline drawing is subject to change			