

DIN 332-DR M20
DIN 6885 Teil1

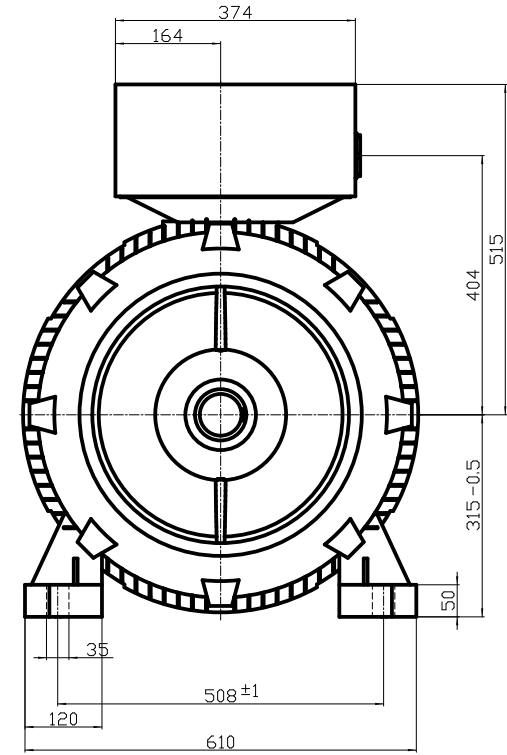
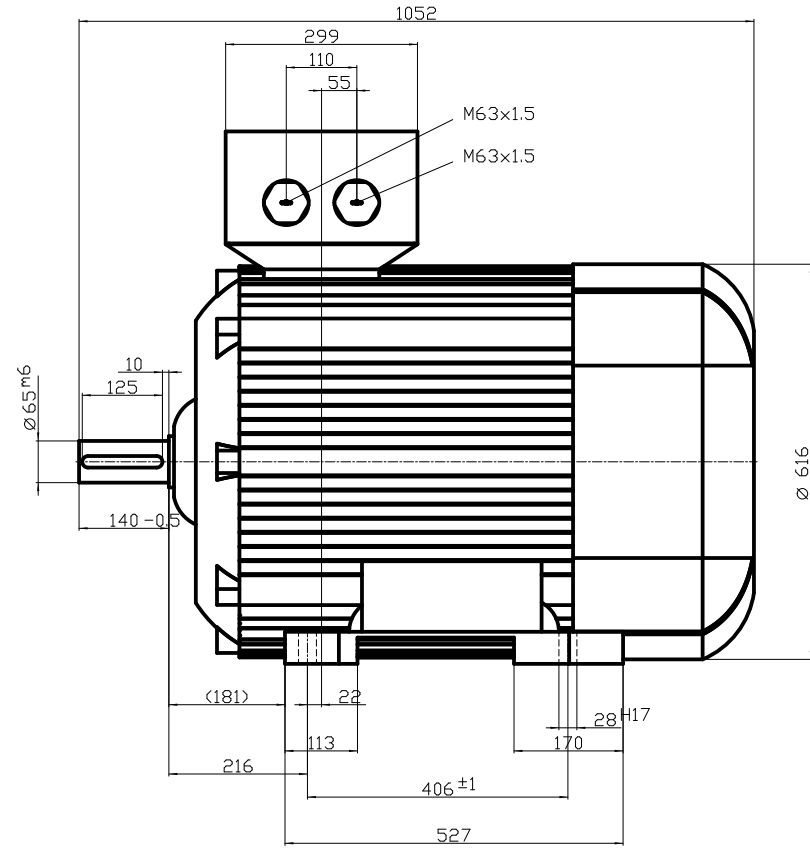

		-	
		-	
Unit	mm	1TZ9503-3AA03-4AA4	
Date	22/07/2014		
<small>Diese Umrisszeichnung ist Änderungen vorbehalten / This outline drawing is subject to change</small>			