

1 2 3 4 5 6 7 8

A

B

C

D

E

F

A

B

C

D

E

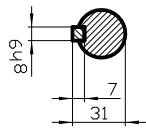

DIN 332-DR M10  
DIN 6885 Teil1

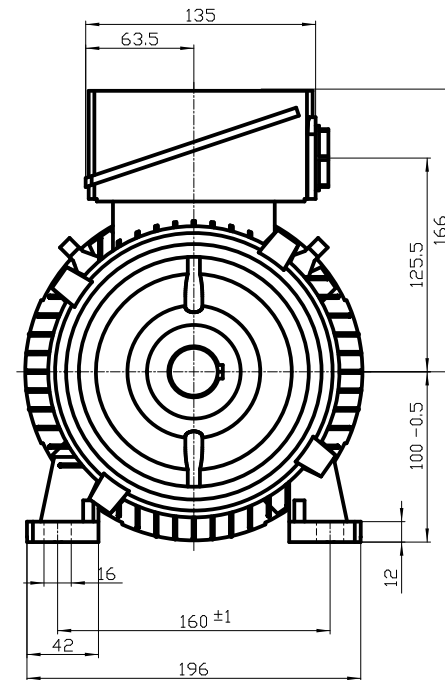
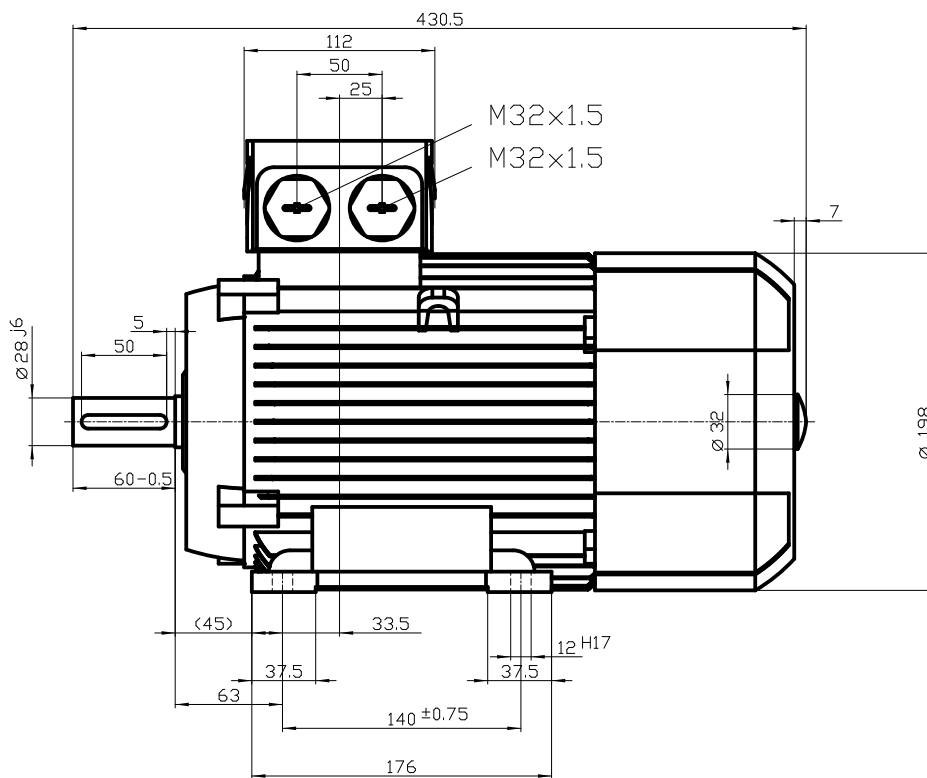

		-	
		-	
Unit	mm	1TZ9003-1AB53-4AA4	
Date	22/07/2014		
<small>Diese Umrisszeichnung ist Änderungen vorbehalten / This outline drawing is subject to change</small>			

1 2 3 4 5 6 7 8